

Technische Daten:

Werkstoff:

Polyamid

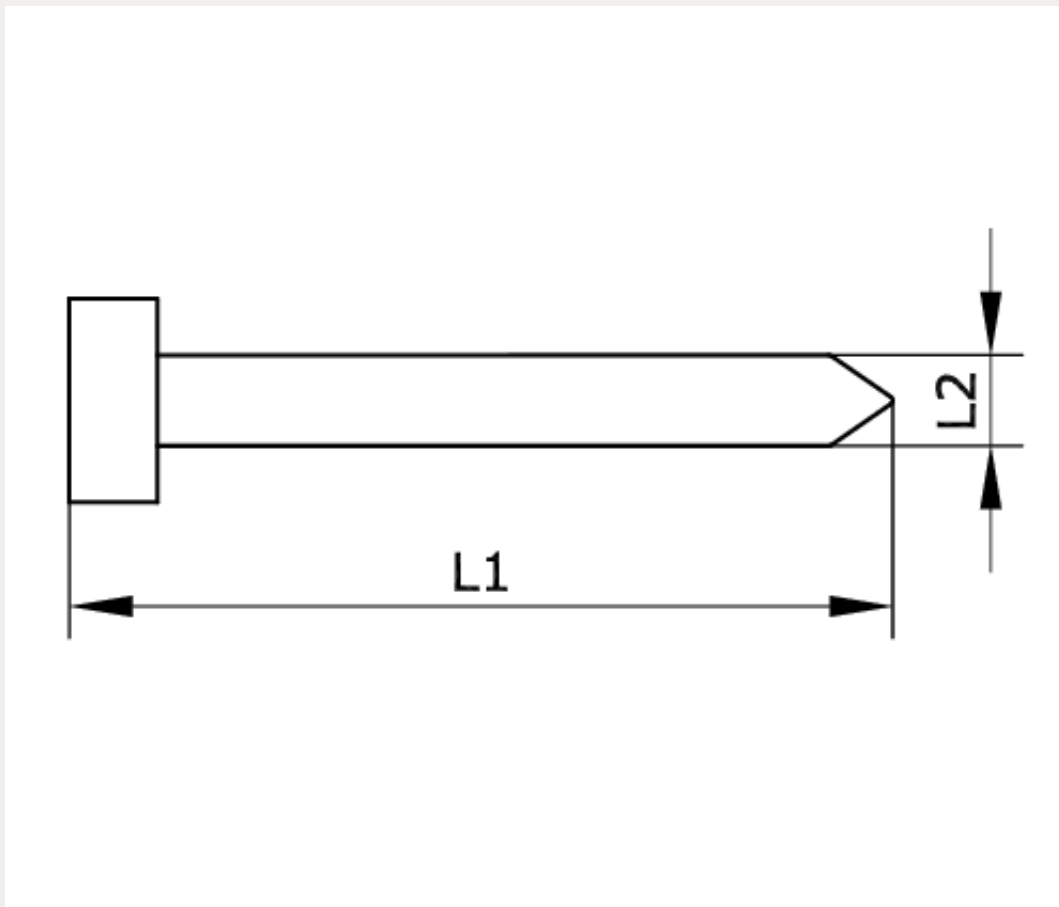
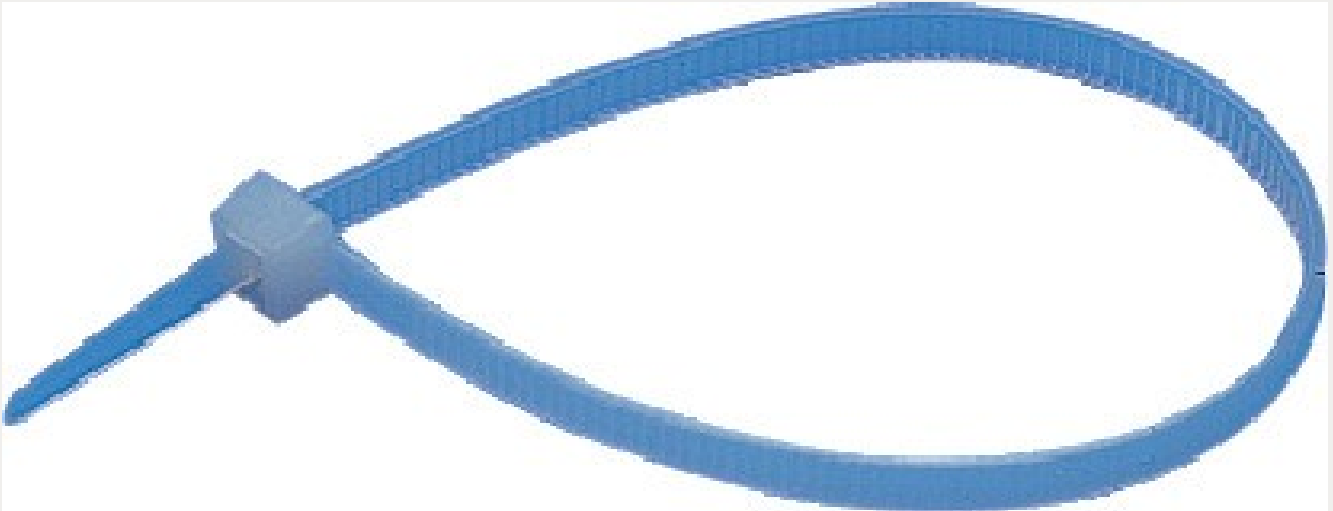

Artikelnummer	Abmessung	L1	L2
260987	2,5 x 100	100	2,5

max. Binde-Ø
25