

Technische Daten:

Werkstoff Gehäuse:	Messing
Werkstoff Griff:	Polypropylen
Temperaturbereich:	-10 °C bis +50 °C

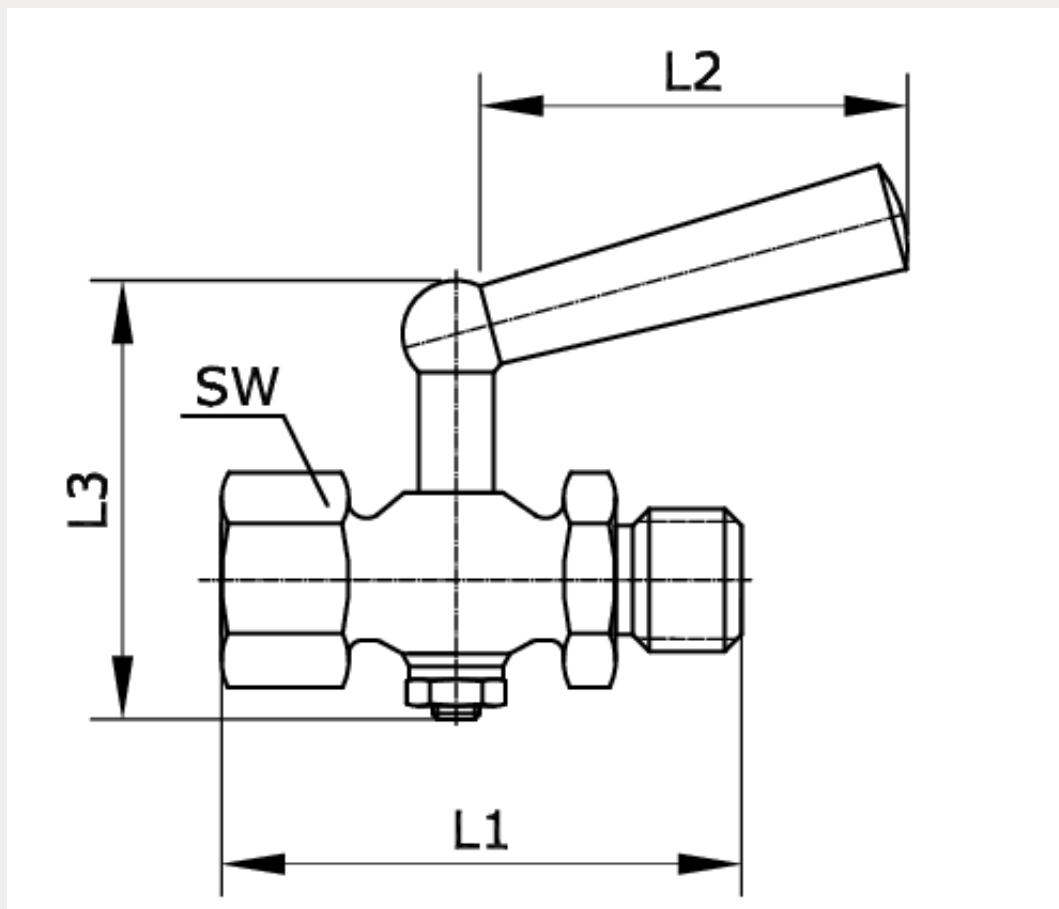

Artikelnummer	Reihenfolge	Anschluss	L1
261165	290	G 1/4 i - G 1/4 a	43
L2	L3	PN	SW
36	42	6 bar	17